

MADE IN ITALY



Spezie

SPICES

A SELECTION OF KITCHENS
DESIGNED AND PRODUCED IN ITALY

UNA SELECCIÓN DE COCINAS
DISEÑADAS Y PRODUCIDAS EN ITALIA

Spezie

SPICES

This is our first menu, a selection of entrees **featuring a few select models** and trendiest finishes to give you a taste of the dishes that are to come.

We draw on the knowledge of the kitchen environment acquired in Italy, to bring to America **that taste that distinguishes Italians** around the world as lovers of fine simple cuisine.

Welcome back to the basics.

*Este es nuestro primer menú, una **selección de entradas con modelos exclusivos** y acabados más actuales para darle un sabor de los platos que están por venir.*

*Nos basamos en el conocimiento del ambiente de cocina adquirido en Italia, para traer a América **ese sabor que distingue a los italianos** alrededor del mundo como amantes de la buena cocina simple.*

¡Bienvenido de nuevo a lo básico.

A brand with a meaning,
a brand that is a statement.

*Una marca con un
significado, una marca
que es una declaración.*



02 Company manifesto

Kitchen models

- 07 Sage
- 22 Basil
- 32 Rosemary

40 Modules and Accessories

50 Bathrooms and Vanities

INTERNI is an Italian word, a word which means INTERIORS.

With this name, we want to communicate that **we are an interior manufacturing company**, with our Italian identity clearly expressed.

We don't use Italian names or Italian sounds just to confuse our clients.

We use an Italian name and the Italian Flag because **we are Italians and our products are 100% Made in Italy.**

INTERNI es una palabra italiana que significa **INTERIORES.**

Con este nombre, queremos comunicar que somos una **empresa de fabricación de interiores**, con nuestra identidad italiana expresado claramente.

No utilizamos nombres italianos o sonidos italianos sólo para confundir a nuestros clientes.

Usamos un nombre italiano y la bandera italiana porque **somos italianos y nuestros productos son 100% Hecho en Italia.**

AVAILABLE DOORS AND FINISHES
ACABADOS Y PUERTAS DISPONIBLES

Model SAGE

FLAT DOOR

Flat doors for base, column and wall units. When used with base and column cabinets these doors require a handle. When used with wall units these doors extend out at the bottom of the cabinet, providing a practical invisible handhold.

PUERTA PLANA

Puerta para unidades de base, columna y pared. Cuando se utiliza con gabinetes de base y columna, este tipo de puerta necesita una manija. Cuando se utiliza con unidades de pared, este tipo de puerta se extiende en la parte inferior del gabinete, proporcionando un asidero práctico invisible.



Melamine Rovere Seppia Melamine Rovere Greige Gloss Lacquered Alps Gray Gloss Lacquered Cortina White

Model BASIL

INTEGRATED HANDLE DOOR

Doors with integrated handles for base or column cabinets, featuring an elegant J-groove which do not require an additional handle.

PUERTA CON MANIJA INTEGRADA

Puertas con empuñaduras integradas para los gabinetes de base o columna, con una elegante ranura J que no requiere una manija adicional.



Melamine Rovere Seppia Melamine Rovere Greige Gloss Lacquered Alps Gray Gloss Lacquered Cortina White

Model ROSEMARY

SHAKER DOOR

Doors with an elegant recessed frame for base, column and wall units. When used with base and column cabinets these doors require a handle. When used with wall units these doors extend out at the bottom of the cabinet, providing a practical invisible handhold.

PUERTA SHAKER

Puertas con un elegante marco empotrado para unidades de base, columna y pared. Cuando se utiliza con gabinetes de base y columna, este tipo de puerta necesita una manija. Cuando se utiliza con unidades de pared, este tipo de puerta se extiende en la parte inferior del gabinete, proporcionando un asidero práctico invisible.



Matt Lacquered Espresso brown Matt Lacquered Ashes Gray Matt Lacquered Flower white

GLASS DOOR

Stopsol glass insert doors with a Matt Black aluminum frame, ideal for wall units illuminated from the inside and equipped with transparent shelves.

PUERTA DE CRISTAL

Puertas de cristal Stopsol con marco de aluminio negro mate, ideal para gabinetes de pared iluminados desde el interior y equipados con estantes transparentes.



Stopsol glass

Spices are a key element of a great recipe. When used in recipes, spices enhance **flavor, texture and color.**

IN ITALIAN CUISINE SPICES ARE A GARNISH ESSENTIAL FOR THE CREATION OF UNIQUE AND RECOGNIZABLE DISHES.

Espicias son un elemento clave de una buena receta. Cuando utilizadas en recetas, especias mejoran sabor, textura y color.

EN LA COCINA ITALIANA ESPECIAS SON ESENCIALES PARA LA CREACIÓN DE PLATOS ÚNICOS Y RECONOCIBLES.

Spezie means “spices” in Italian.

Spezie significa especias en Italiano.

Spices are the symbol of a **rooted tradition**, always present in essence, while **refined in processing and use.**

Spices are the symbol of simple cuisine, enriched by the clever use of **balanced combinations** and attention to detail.

Espicias son el símbolo de una tradición arraigada, siempre presentes en esencia, pero refinados en el procesamiento y uso.

Espicias son el símbolo de una cocina sencilla, enriquecida por el uso inteligente de combinaciones balanceadas y atención al detalle.

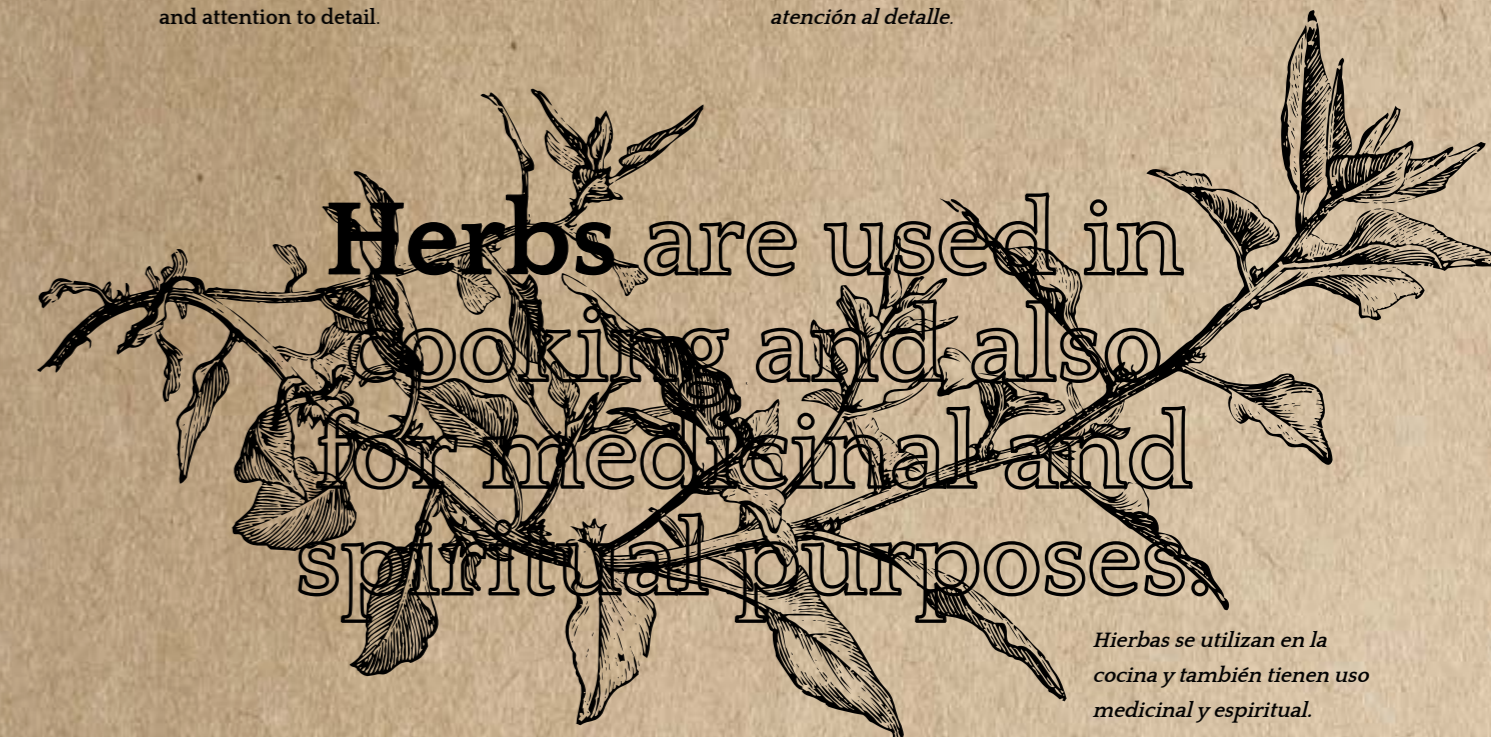

Hierbas se utilizan en la cocina y también tienen uso medicinal y espiritual.

In Italy, our **knowledge** of refined traditional cooking has **evolved** together with our **culture** to our concept of the **modern kitchen.**

INTERNI cucine keeps alive the taste for the right proportion of the fundamental elements of design, the **pleasure of touching beautiful textures**, the visual importance of meticulous finishes, the need for **simplicity in design**, and the joy of living comfortably within your own space.

A taste that has been refined throughout Europe, **shaped by time and changes in style and technology**, is now available as a **quality choice at a competitive price** even in America.

En Italia, nuestro conocimiento de la refinada cocina tradicional ha evolucionado junto con nuestra cultura y nuestro concepto de la cocina moderna.

INTERNI cucine mantiene vivo el gusto por la proporción correcta de los elementos fundamentales del diseño, el placer de tocar hermosas texturas, la importancia visual de acabados meticulosos, la necesidad de simplicidad en el diseño y la alegría de vivir cómodamente dentro de su propio espacio.

Un gusto que ha sido perfeccionado a lo largo de Europa, formado por el tiempo y cambios en estilo y tecnología, está ahora disponible como una opción de calidad a un precio competitivo incluso en los Estados Unidos.

Italian quality,
made to last.

Calidad italiana,
hecho para durar.

We deliver a **quality tested product**, made to last, just as it was done in the Old World.

We believe in the kitchen that wants to be lived in every single day. We are just as proud to use **simple and natural ingredients** to build **healthy pieces of furniture** for your home, as we are when we prepare exquisite Italian dishes.

Entregamos un producto de calidad probado, hecho para perdurar, tal y como fue hecho en el viejo mundo.

*Creemos en la cocina que quiere vivir cada día. Somos orgullosos de utilizar **ingredientes simples y naturales** para construir piezas de **muebles sanas** para su hogar, de igual manera que preparamos exquisitos platos italianos.*

OUR RECIPE FOR A
GOOD PROJECT

NUESTRA RECETA PARA
UN BUEN PROYECTO



RAW MATERIALS FROM
RENEWABLE SOURCES
MATERIAS PRIMAS DE
FUENTES RENOVABLES



PRECISE DESIGN
DISEÑO PRECISO

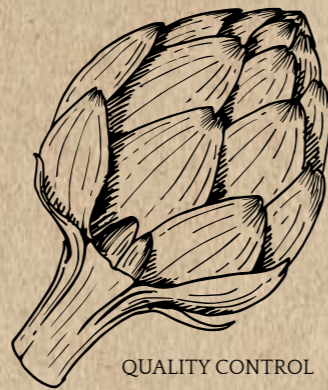

QUALITY CONTROL
CONTROL DE CALIDAD



AFTER SALE
SERVICES
SERVICIO DESPUES
DE LA VENTA



Every step in the production of every **INTERNI cucine** kitchen follows strict European regulations, **design standards and quality control checks**. And, because our kitchens are produced in Italy for enjoyment in America, our approach to solid construction, **modular design and fast delivery** ensures an **easy installation** and your ultimate satisfaction with our product.

*Cada paso en la producción de cada cocina **INTERNI cucine** sigue estrictas normas europeas, normas de **diseño y controles de calidad**. Y, porque nuestras cocinas son producidas en Italia para disfrute en América, nuestro enfoque en la construcción sólida, **diseño modular y entrega rápida** aseguran una **fácil instalación** y su máxima satisfacción con nuestro producto.*

A century of
expertise.

Más de un siglo
de experiencia.

Our business concept is based on a **select group of quality Italian manufacturers**, partnered together to offer their products directly to the American market, for both retail and contractor projects, without a middleman to increase costs to the consumer.

*Nuestro concepto de negocio se basa en un **selecto grupo de fabricantes italianos** de calidad, asociados para ofrecer sus productos directamente al mercado estadounidense, para proyectos al por menor y también al por mayor, sin intermediarios que incrementan los costos al consumidor.*

These combined stories
bring together
more than 110 years
of expertise.

Estas historias combinadas reúnen a más de 110 años de experiencia.

In our factories in Italy, we use **eco-friendly and noble materials** in our construction, together with real Italian craftsmanship and attention to detail.

*En nuestras fábricas en Italia, utilizamos **materiales nobles y ecológicos** en nuestra construcción, junto con la **artesanía italiana y atención al detalle**.*

In the United States, we have a **network of thousands of distribution points** and shops equipped with Italian woodworking machinery and painting plants to adequately support all of our retailer, designer and consumer needs.

*En los Estados Unidos, contamos con una **red de miles de puntos de distribución** y tiendas equipadas con maquinaria italiana para la madera y plantas de pintura para **apoyar adecuadamente a todas las necesidades del diseñador y el consumidor**.*

ROOTED IN TRADITION,
GROWN WITH CULTURE
AND TECHNOLOGY

ARRAIGADO EN LA
TRADICIÓN, CRIADO CON
CULTURA Y TECNOLOGÍA



Contract for larger projects.

Over the years, the company has successfully leveraged its versatility, experience and knowledge gained in the market to develop **new projects for the contractor market.**

INTERNI cucine has the combined experience of more than 250 years with multi-unit projects such as **condominiums, rental apartments, renovations, and other commercial projects.** We strive to work together with our clients to find the perfect solution for a **quality product that will fit their budget.**

INTERNI cucine collaborates with architects to optimize layouts for cabinetry, using standard dimensions to keep prices under control. Detailed shop drawings in centimeters and inches are created before starting production. We can also prepare samples and mock-ups in a very short time.

We have 5,000 square feet of shop and pre-assembly space to make alterations and modifications if necessary. During production we activate more than 5,000 quality control tests to ensure compliance with UNI EN ISO 9001:08, and **on-time delivery of products increases the value of the project itself.**

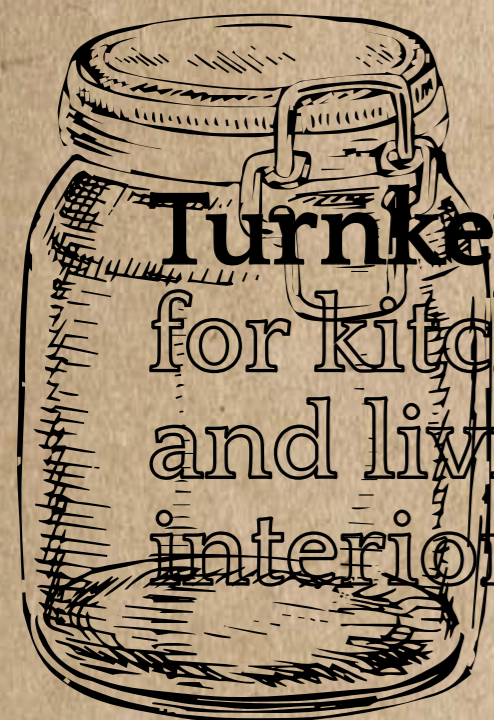

Turnkey projects for kitchens, baths and living areas. Full interior solutions.

Contrato para proyectos más grandes.

*A través de los años, la empresa ha aprovechado con éxito su versatilidad, experiencia y conocimientos adquiridos en el mercado para desarrollar **nuevos proyectos al por mayor para el contratista.***

*INTERNI cucine tiene más de 250 años de experiencia combinada con múltiples proyectos como **condominios, apartamentos, proyectos de remodelación y otros proyectos comerciales.** Nos esforzamos por trabajar junto con nuestros clientes para encontrar la solución perfecta para un **producto de calidad que se ajuste a su presupuesto.***

INTERNI cucine colabora con arquitectos para optimizar diseños de gabinetes, con dimensiones estándar para mantener los precios bajo control. Planos de taller detallados en centímetros y pulgadas se crean antes de comenzar la producción. También podemos preparar muestras y maquetas en muy poco tiempo.

Tenemos 5.000 pies cuadrados de tienda y espacio de pre-ensambla para hacer alteraciones y modificaciones si son necesarias. Durante la producción activamos más de 5.000 pruebas de control de calidad para garantizar el cumplimiento de 9001:08 de la UNI EN ISO, y el tiempo de entrega de los productos aumenta el valor del proyecto.

Proyectos llave en mano para cocinas, baños y zonas de estar. Soluciones completas para interiores.

MODEL SAGE - FLAT DOORS

Sage

The Italian word for sage, *salvia*, derives from the Latin *salus*, which means health, safety or well-being.

Sage was sought, studied and used for medicinal purposes long before it was used in the kitchen.

La palabra italiana para salvia, salvia, deriva del latín salus, que significa salud, seguridad o bienestar.

Salvia fue buscada, estudiada y usada para propósitos medicinales muchos antes de que fue utilizada en la cocina.





Sage - #01

Linear composition with bases and column with flat doors in Melamine Rovere Seppia finish, wall units with flat doors in Gloss Lacquered Cortina White finish.



Sage - #01

Above: detail of base storage unit with flat doors in Melamine Rovere Seppia finish with 2030 handles.

Right page: detail a "Ten" drawer with 2030 handle and "whitty-line" cutlery holder in Gray Vesuvio finish.





Sage - #02

Linear composition with bases and island with integrated handle door, columns and wall units with flat doors in Gloss Lacquered Alps Gray finish. 2 wall units with Glass doors.





Sage - #02

Above: detail of base drawer unit with integrated handle doors in Gloss Lacquered Alps Gray finish with bins for differentiated garbage.

Left page: detail of island base storage units with flat doors in Gloss Lacquered Alps Gray finish.

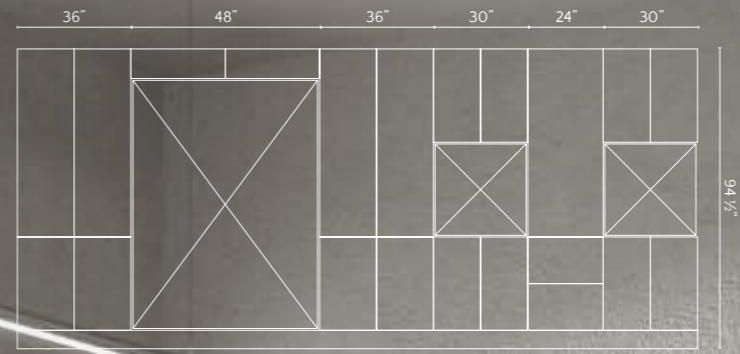
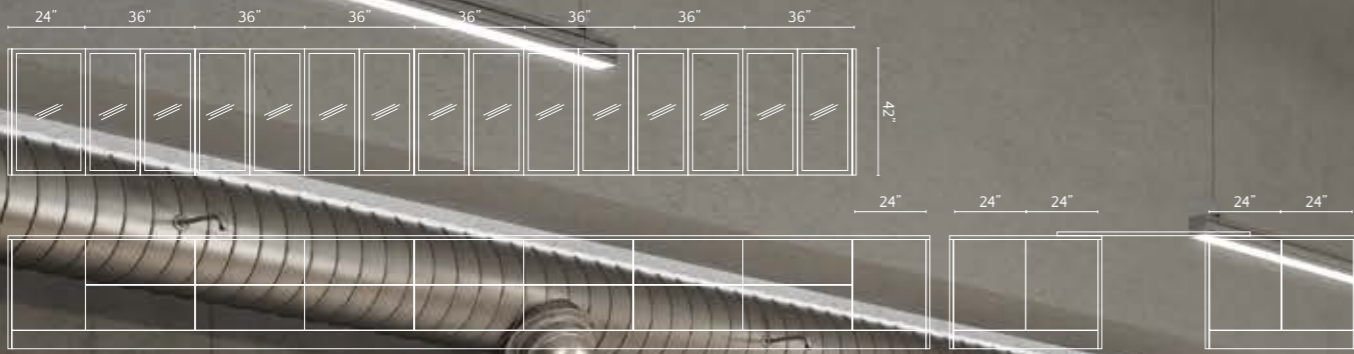

Sage - #03

Composition with bases and columns with flat doors in Gloss Lacquered Cortina White finish, wall units with glass doors.



Sage - #03

Above: detail of bases with storage unit and drawers with flat doors in Gloss Lacquered Cortina White finish, wall units with glass insert doors.

Right page: detail of islands base units with flat doors in Gloss Lacquered Cortina White finish.



Sage - #03

Columns linear composition with flat doors in Gloss Lacquered Cortina White finish.

MODEL BASIL - INTEGRATED HANDLE DOOR

Basil

Basil is undoubtedly the most popular herb in Italy. It is most commonly used fresh in recipes, as in the beloved Insalate Caprese, as well as tomato sauces.

Basil is one of the main ingredients in **pesto**, a green Italian oil-and-herb sauce.

La albahaca es, sin duda, la hierba más popular en Italia. Comúnmente se utiliza en recetas como el amado Insalate Caprese, así como salsas de tomate.

La albahaca es uno de los ingredientes principales del pesto, una salsa verde de hierbas y aceite italiana.

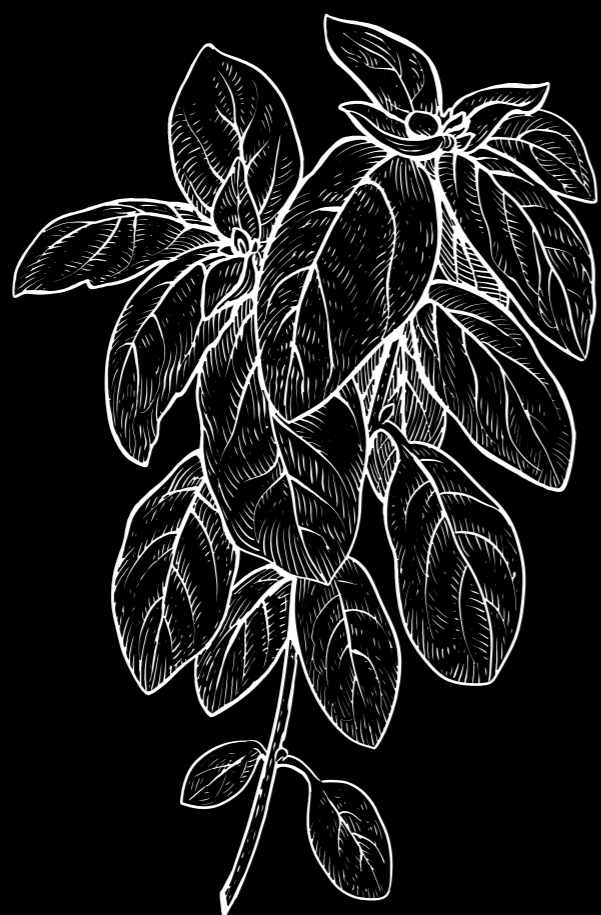

Basil - #01

Detail of wall units with flat doors in Gloss Lacquered Cortina White finish and Glass doors with Stopsol mirrored glass.





Basil - #01

Corner composition with bases and island with integrated handle doors in Melamine Rovere Seppia finish, columns with integrated door handles in Gloss Lacquered Cortina White finish, wall units with flat doors in Gloss Lacquered Cortina White finish. 4 wall units with Glass doors.



Basil - #01

Above: detail of Shelve system, a base unit with structure in Matt Black aluminum, shelves in Melamine Rovere Seppia finish.

Left page: detail of column storage unit with flat integrated door handles in Gloss Lacquered Cortina White finish with pull-out baskets accessory.

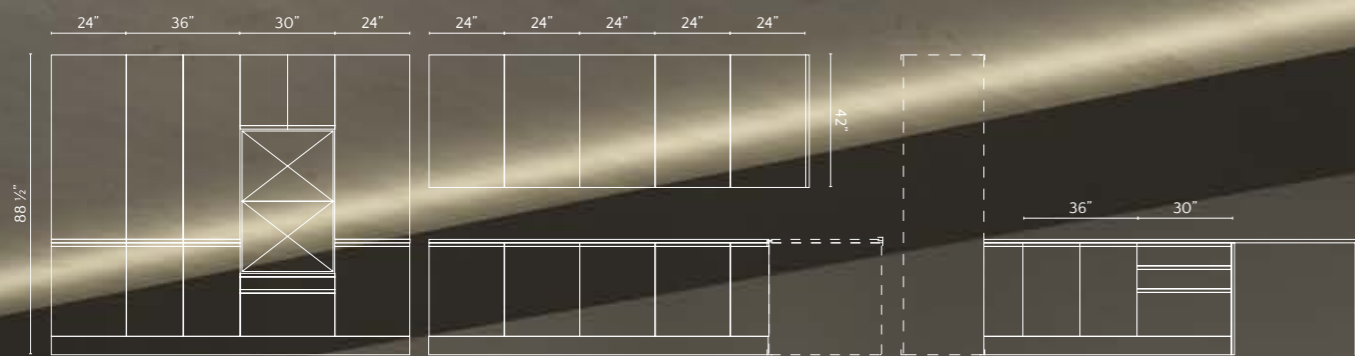

Basil - #02

Horseshoe composition with peninsula with bases and columns with integrated handle door in Melamine Rovere Greige finish and wall units with flat doors in Gloss Lacquered Alps Gray finish.





Basil - #02
Above: detail of column storage unit with integrated handle doors in Melamine Rovere Greige finish.
Right page: detail of drawer base unit with integrated handle door in Melamine Rovere Greige finish.



MODEL ROSEMARY - SHAKER DOOR

Rosemary

Rosemary is a familiar sight in the Italian countryside, growing in the wild throughout Italy and the rest of the Mediterranean region.

It is a very popular herb in Italian cooking, often used in vegetable preparations and to aromatize olive oil.

El Romero es una vista familiar en la campiña italiana, creciendo en estado silvestre en toda Italia y el resto de la región mediterránea.

Es una hierba muy popular en la cocina italiana, de uso frecuente en preparaciones vegetales y para aromatizar el aceite de oliva.



Rosemary - #01
Detail of sink drawers unit with shaker door in Matt Lacquered Ashes Gray finish.



Rosemary - #02

Composition with bases, columns and wall units with shaker doors in Matt Lacquered Flower White finish, island with shaker doors in Matt Lacquered Espresso Brown finish.



Rosemary - #02

Detail of bases and wall units with shaker doors in Matt Lacquered Flower White finish.

Modularity / compositional elements

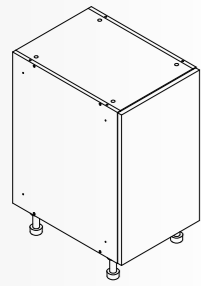

Base unit 1 door
1 shelf included, right/left opening

Width: 9, 12, 15, 18, 21, 24"
Height: 34 1/2"
Depth: 24"

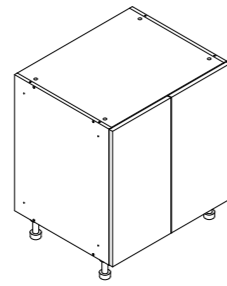

Base unit 2 doors
1 shelf included

Width: 27, 30, 36, 42"
Height: 34 1/2"
Depth: 24"

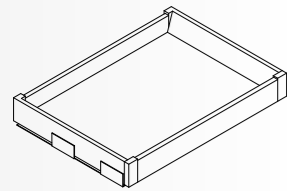

Internal drawers

Width: 18, 24, 30, 36, 42"
Height: 4"
Depth: 24"

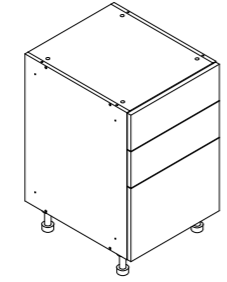

Base unit 3 drawers

Width: 15, 18, 21, 24"
Height: 34 1/2"
Depth: 24"

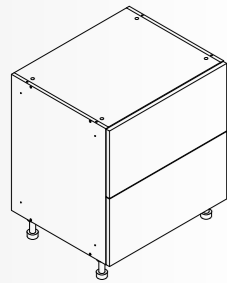

Base unit 2 drawers

Width: 24, 30, 36, 42"
Height: 34 1/2"
Depth: 24"

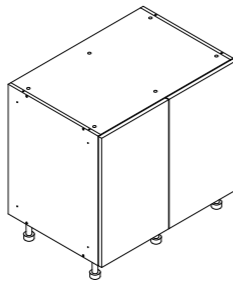

Base unit 2 doors sink

Width: 30, 36"
Height: 34 1/2"
Depth: 24"

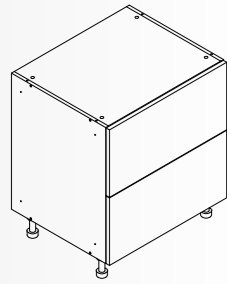

Base unit 2 drawers sink

Width: 24, 30, 36, 42"
Height: 34 1/2"
Depth: 24"

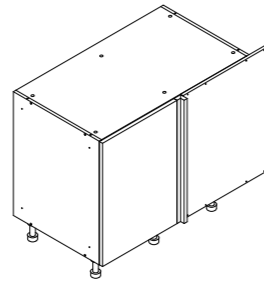

Corner base unit 1 doors
Specify left/right fixed side

Width: 40, 46"
Height: 34 1/2"
Depth: 25"

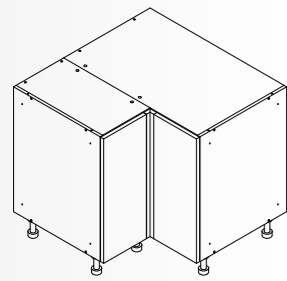

Corner base units "L" 2 doors

Width: 38"
Height: 34 1/2"
Depth: 38"

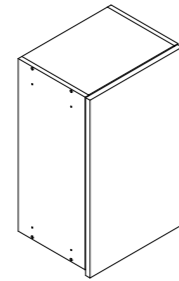

Wall unit 1 door
1 shelf included, right/left opening

Width: 9, 12, 15, 18, 21, 24"
Height: 30"
Depth: 13"

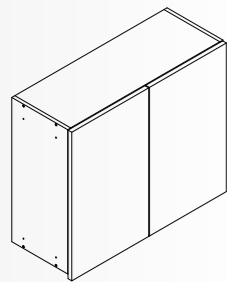

Wall unit 2 doors
1 shelf included

Width: 27, 30, 36, 42"
Height: 30"
Depth: 13"

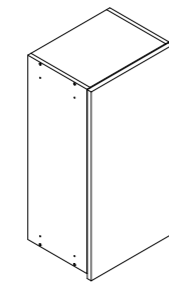

Wall unit 1 door
2 shelves included, right/left opening

Width: 9, 12, 15, 18, 21, 24"
Height: 36"
Depth: 13"

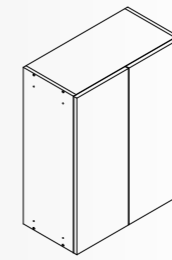

Wall unit 2 doors
2 shelves included

Width: 27, 30, 36, 36"
Height: 36"
Depth: 13"

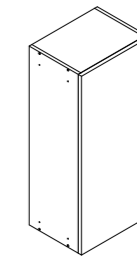

Wall unit 1 door
2 shelves included, right/left opening

Width: 9, 12, 15, 18, 21, 24"
Height: 42"
Depth: 13"

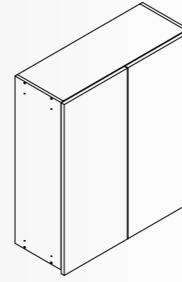

Wall unit 2 doors
2 shelves included

Width: 27, 30, 36, 42"
Height: 42"
Depth: 13"

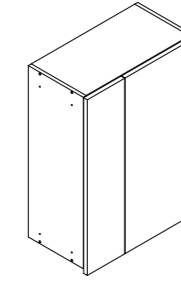

Wall straight corner 1 doors
Right/left fixed side

Width: 26"
Height: 30, 36, 42"
Depth: 13"

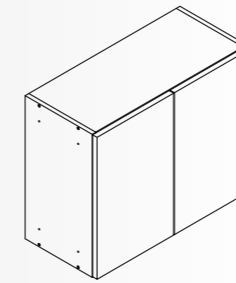

Over appliance wall unit 2 doors W.30"

Width: 30"
Height: 15, 18, 24"
Depth: 13"

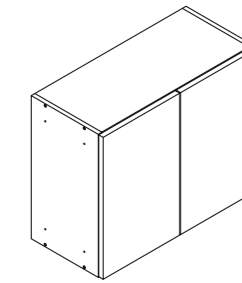

Over appliance wall unit 2 doors W.36"

Width: 36"
Height: 15, 18, 21"
Depth: 13"

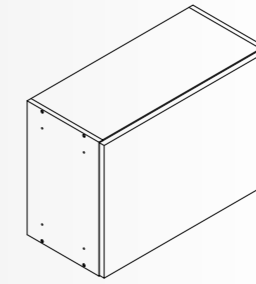

Lift up cabinets W.30"

Width: 30"
Height: 15, 18, 21"
Depth: 13"

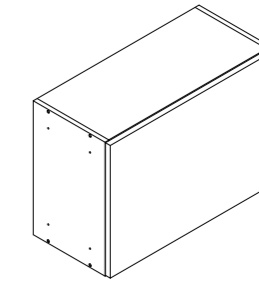

Lift up cabinets W.36"

Width: 36"
Height: 15, 18, 21"
Depth: 13"

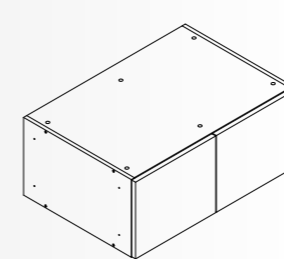

Over fridge 2 doors W.30"

Width: 30"
Height: 18, 24"
Depth: 24"

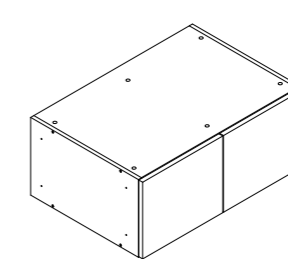

Over fridge 2 doors W.36"

Width: 36"
Height: 12, 15, 18, 21"
Depth: 24"

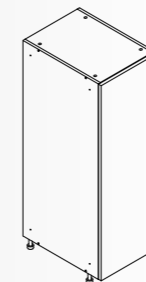

Pantry 1 door W.15"
3 shelves included, right/left opening

Width: 15"
Height: 57 1/2, 62 1/2, 64 1/2"
Depth: 24"

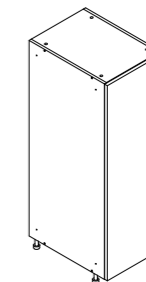

Pantry 1 door W.18"
3 shelves included, right/left opening

Width: 18"
Height: 57 1/2, 62 1/2, 64 1/2"
Depth: 24"

Modularity / compositional elements

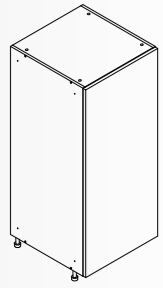

Pantry 1 door W.24"
3 shelves included, right/left opening

Width: 24"
Height: 57 1/2, 62 1/2, 64 1/2"
Depth: 24"

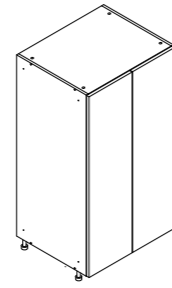

Pantry 2 doors W.30"
3 shelves included

Width: 30"
Height: 57 1/2, 62 1/2, 64 1/2"
Depth: 24"

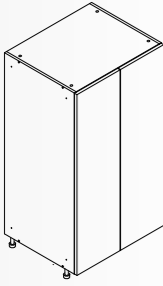

Pantry 2 doors W.36"
3 shelves included

Width: 36"
Height: 57 1/2, 62 1/2, 64 1/2"
Depth: 24"

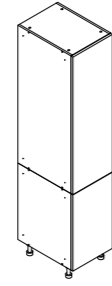

Column 1 door W.15"
4 shelves included, right/left opening

Width: 15"
Height: 83 1/2, 88 1/2, 94 1/2"
Depth: 24"

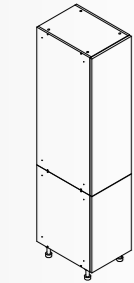

Column 1 door W.18"
4 shelves included, right/left opening

Width: 18"
Height: 83 1/2, 88 1/2, 94 1/2"
Depth: 24"

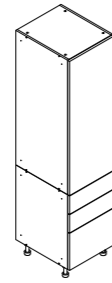

Column 1 door 3 drawers W.15"
3 shelves included, right/left opening

Width: 15"
Height: 83 1/2, 88 1/2, 94 1/2"
Depth: 24"

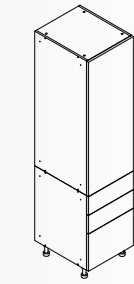

Column 1 door 3 drawers W.18"
3 shelves included, right/left opening

Width: 18"
Height: 83 1/2, 88 1/2, 94 1/2"
Depth: 24"

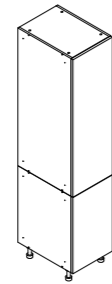

Column 1 door W.24"
4 shelves included, right/left opening

Width: 24"
Height: 83 1/2, 88 1/2, 94 1/2"
Depth: 24"

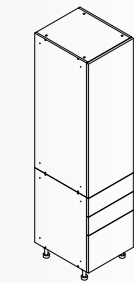

Column 1 door 3 drawers W.24"
3 shelves included, right/left opening

Width: 24"
Height: 83 1/2, 88 1/2, 94 1/2"
Depth: 24"

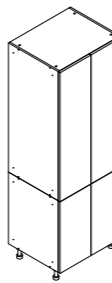

Column 2 doors W.30"
4 shelves included

Width: 30"
Height: 83 1/2, 88 1/2, 94 1/2"
Depth: 24"

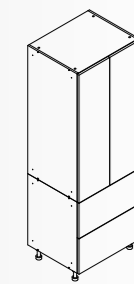

Column 2 doors 2 drawers W.30"
3 shelves included

Width: 30"
Height: 83 1/2, 88 1/2, 94 1/2"
Depth: 24"



Column 2 doors W.36"
4 shelves included

Width: 36"
Height: 83 1/2, 88 1/2, 94 1/2"
Depth: 24"

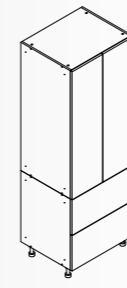

Column 2 doors 2 drawers W.36"
3 shelves included

Width: 36"
Height: 83 1/2, 88 1/2, 94 1/2"
Depth: 24"

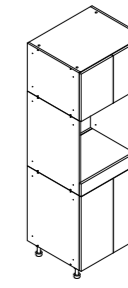

Oven column 2 doors
Lower pantry H.30", upper pantry H.19"

Width: 30"
Height: 83 1/2"
Depth: 24"



Oven column 2 doors 2 drawers
Drawers H.30", upper pantry H.19"

Width: 30"
Height: 83 1/2"
Depth: 24"

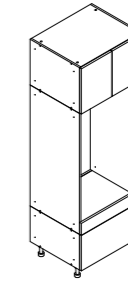

Double oven column 2 doors 1 drawer
Drawer H.15", upper pantry H.13"

Width: 30"
Height: 83 1/2"
Depth: 24"

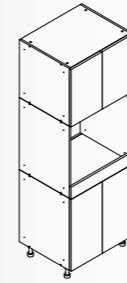

Oven column 2 doors
Lower pantry H.30", upper pantry H.24"

Width: 30"
Height: 88 1/2"
Depth: 24"

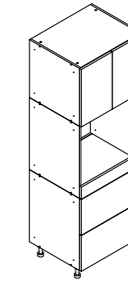

Oven column 2 doors 2 drawers
Drawers H.30", upper pantry H.24"

Width: 30"
Height: 88 1/2"
Depth: 24"

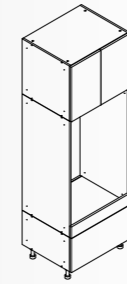

Double oven column 2 doors 1 drawer
Drawer H.15", upper pantry H.19"

Width: 30"
Height: 88 1/2"
Depth: 24"

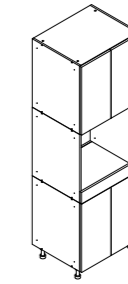

Oven column 2 doors
Lower pantry H.30", upper pantry H.30"

Width: 30"
Height: 94 1/2"
Depth: 24"

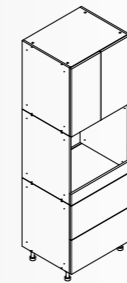

Oven column 2 doors 2 drawers
Drawers H.30", upper pantry H.30"

Width: 30"
Height: 94 1/2"
Depth: 24"

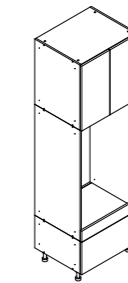

Double oven column 2 doors 1 drawer
Drawer H.15", upper pantry H.24"

Width: 30"
Height: 94 1/2"
Depth: 24"



Side panel D.25"

Width: 3/4"
Height: 29, 84, 89, 95"
Depth: 25"

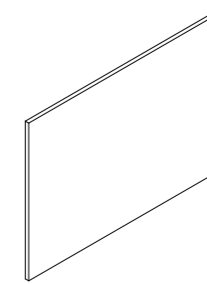

Base side panel D.39"

Width: 3/4"
Height: 35"
Depth: 39"

Modularity / compositional elements

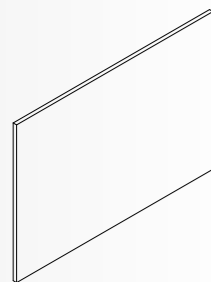

Double side panel D.50"

Width: 3/4"
Height: 35"
Depth: 50"



Side panel D.15"

Width: 3/4"
Height: 30"
Depth: 15"



Side panel D.6"

Width: 3/4"
Height: 30, 35, 36, 42, 96"
Depth: 6"

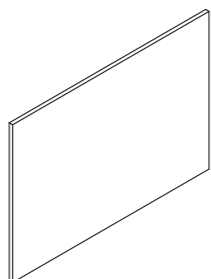

Side panel D.3/4"

Width: 109"
Height: 40"
Depth: 3/4"

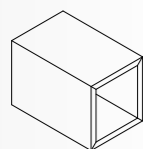

Open hanging unit H.12"

Width: 9, 12"
Height: 12"
Depth: 14"

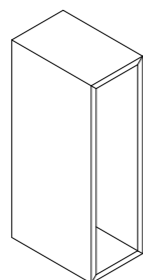

Open hanging unit H.30"

Width: 9, 12"
Height: 30"
Depth: 14"

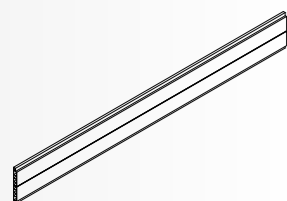

Plinth H.5"

Width: 157"
Height: 5"
Depth: 1/2"



Integrated dishwasher door

Width: 3/4"
Height: 30"
Depth: 24"

Lights

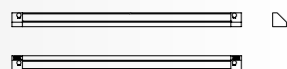

Metro light bar

To be installed inside of the base cabinets and pantry.
Width: 9, 12, 15, 18, 21, 24, 27, 30, 36, 42"

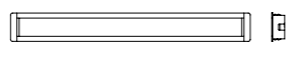

Mirage light bar

To be installed under and inside of the wall units.
Width: 9, 12, 15, 18, 21, 24, 27, 30, 36, 42"

Accessories / inner structures



Extractable bottle-holder 8"

Extractable bottle holder with 10x4mm elliptical shaped wire in chrome finish and white melamine bottom. Extraction guide rails with non-reversible shock absorber right or left.

Module: 8"



Extractable bottle-holder 18"

Extractable bottle holder with 10x4mm elliptical shaped wire in chrome finish and white melamine bottom. All-extraction guides and amortized return. Installation spacers included.

Module: 18"



Extractable bottle-holder 24"

Extractable bottle holder with 10x4mm elliptical shaped wire in chrome finish and white melamine bottom. All-extraction guides and amortized return. Installation spacers included.

Module: 24"



Double pull-out structure

Reversible double pull-out frame H.1150 mm. Predisposition for 180° opening. Load capacity 80kg. 2 internal baskets and 2 door baskets included.

Module: 18"



24" drawer

10x4mm drawer with elliptical section in chrome finish, white melamine bottom. All-extraction guides and amortized return.

Module: 24"

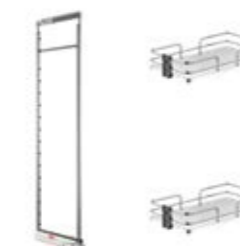

Short column structure frame

Frame for adjustable column 1060-1500 complete with guide, capacity 120 kg with double shock absorber and opening stop adjustment. 2 baskets and extension joint included.



18" kit mechanism corner door

Fly moon kit reversible for corner base from 45 and 60 composed of 2 extractable shelves in white melamine with chromed edge in elliptical section 10x4mm.

Module: 18"



24" kit mechanism corner door

Fly moon kit reversible for corner base from 45 and 60 composed of 2 extractable shelves in white melamine with chromed edge in elliptical section 10x4mm.

Module: 24"



LAZY SUSAN 3/4 for base corner

Kit composed of 2 3/4 turnbuckles for base and column. Single containment wire ring with 10x4mm elliptical section, with white melamine bottom and chromed edge, fast-block coupling system.



18" trash bin cans

Separate waste collection system complete with extraction guides with amortized section and capacity 50 kg. 2 polypropylene containers with handles for easy extraction. Cover included.

Module: 18"



24" trash bin cans

Separate waste collection system complete with extraction guides with amortized section and capacity 50 kg. 2 polypropylene containers with handles for easy extraction. Cover included.

Module: 24"



Extra bin for garbage set

Additional container to be attached to the door and which can be stored inside the waste bins.

Shelvy system

Enhance your kitchen with **aluminum framed base units and wall shelves:** a minimalist choice in industrial style to add a touch of personality to your kitchen.

The Matt Black aluminum supports are elegant frames to shelves produced in wood or lacquered **INTERNI cucine** finishes.

Here below is a diagram of the available modularity. It is also possible to order tailored pieces to meet the needs of the most complex environments, to complete a wall or a niche with style.

Shelvy system wall units standard modules

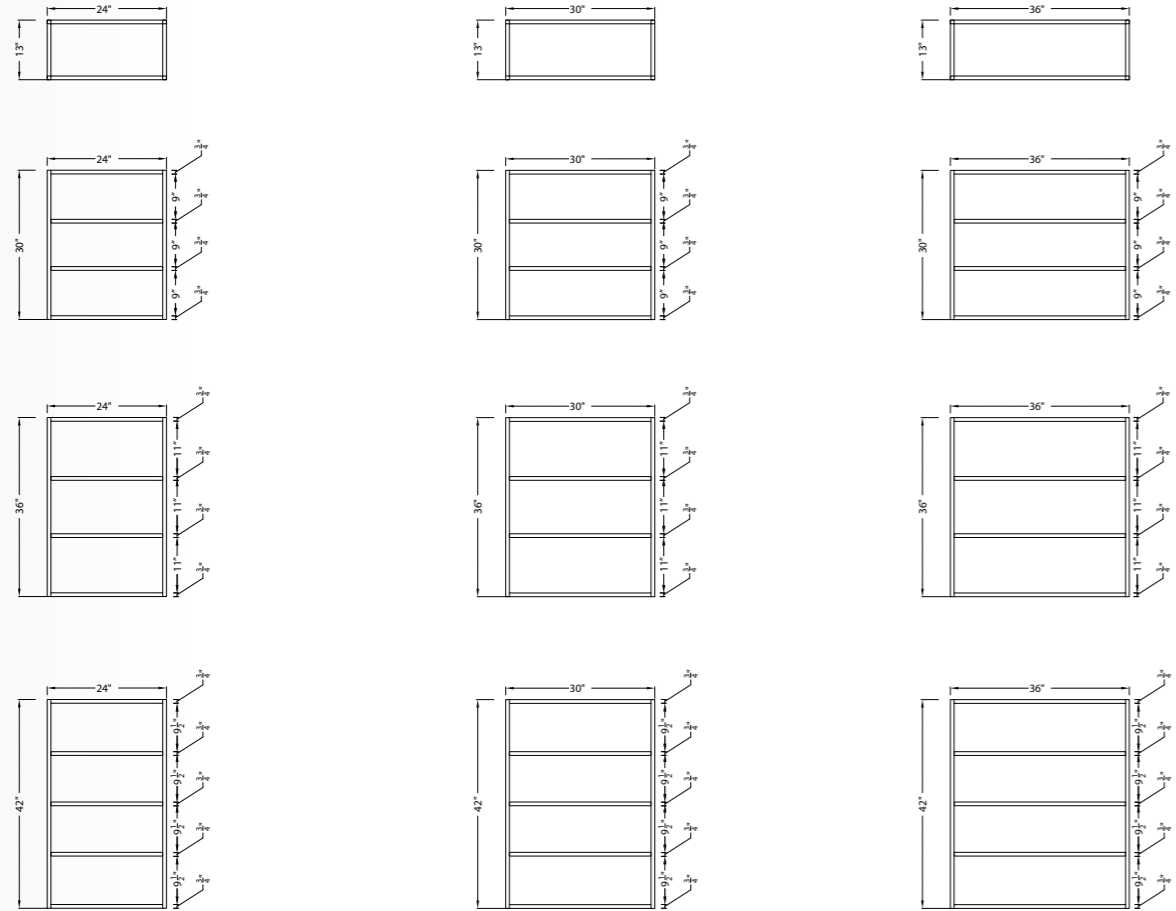

Shelvy system base units standard modules

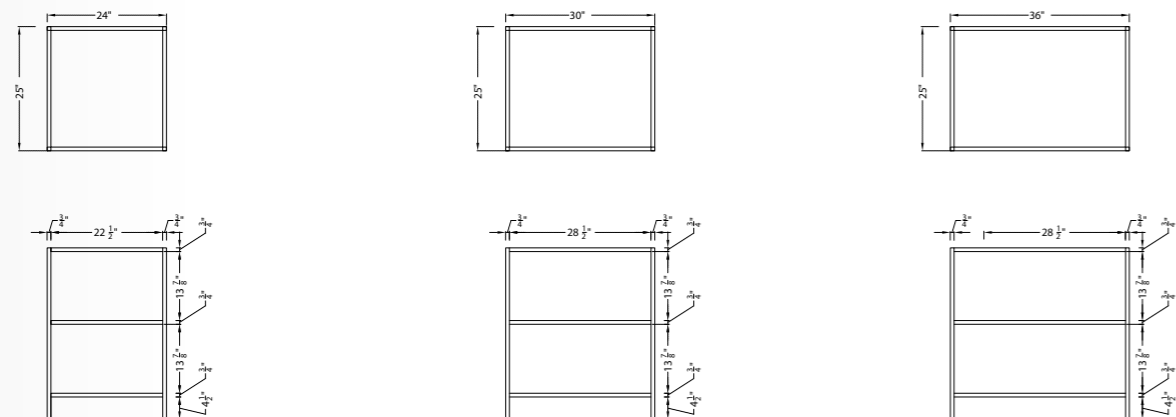

Shelvy system base units standard modules

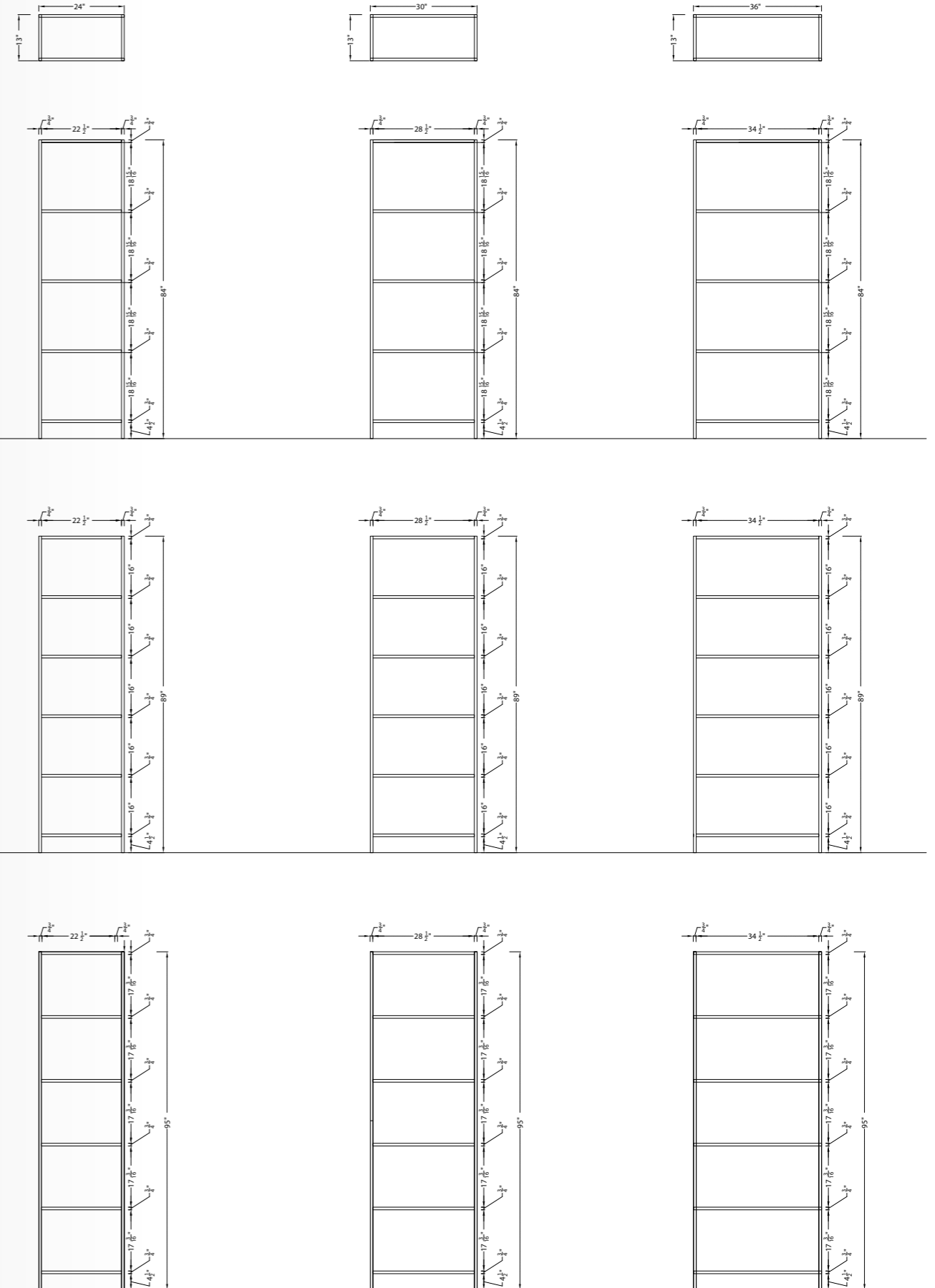

The drawers technology

The drawer "Ten" is the new reference in terms of elegance and design on double-wall drawers. The timeless design will last without losing appeal. Slim shape and perfect curves provide a very elegant look.

The drawer is powered by an all new full extension sliding system with a load capacity of 45kg (99lb) throughout the range, with Dual-Synchro stabilisation for noiseless sliding and a most powerful stop close damper for perfect showroom effect and long lasting function.

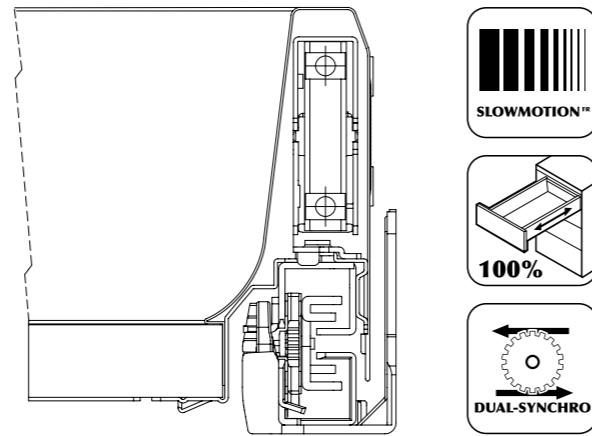

Drawers accessories

15 inch "whitty-line" cutlery holder Vesuvio Gray

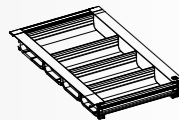

18 inch "whitty-line" cutlery holder Vesuvio Gray

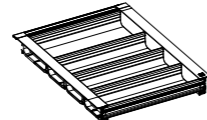

21 inch "whitty-line" cutlery holder Vesuvio Gray

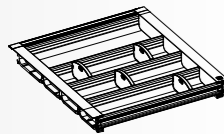

24 inch "whitty-line" cutlery holder Vesuvio Gray

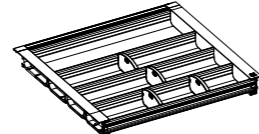

30 inch "whitty-line" cutlery holder Vesuvio Gray

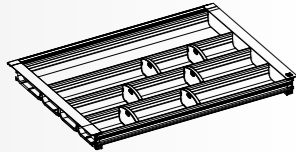

Spices holder insert with 4 cans

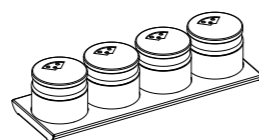

Polyethylene cutlery holder insert



Vesuvio Gray storage insert for drawers



Drawers accessories

Vesuvio Gray roll holder

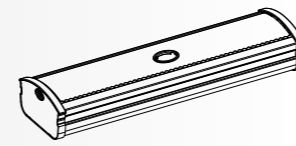

Stainless steel universal spices holder insert

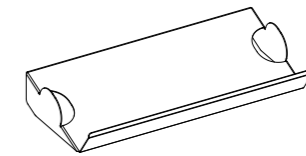

Polyethylene cutter insert

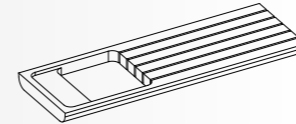

Big drawers accessories

Vesuvio Gray base module for 36 inch "whitty-line" basket

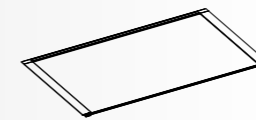

Vesuvio Gray base module for 30 inch "whitty-line" basket

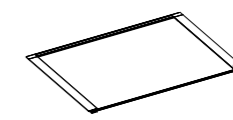

Vesuvio Gray divider insert with stainless steel cover for basket



Vesuvio Gray base module for 42 inch "whitty-line" basket

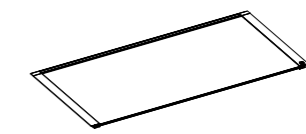

Vesuvio Gray dishes rack insert

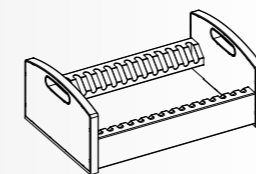

Vesuvio Gray storage insert for basket

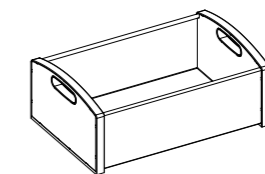

Stainless steel pasta cans holder insert

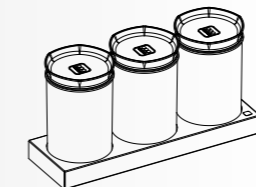

Stainless steel universal spices holder insert

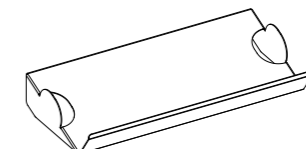

Bathrooms and Vanities

INTERNI cucine makes use of the collaboration of capable Italian partners for the supply of quality wardrobes and bath furniture, as well as for the kitchen environment.

All excellent quality products with countless finishes, available in many styles to complete the coordinated offer for private properties or more complex projects.

The experience of our technicians and the modern Italian taste for beauty come together in a complete design experience.

***INTERNI cucine** hace uso de la colaboración de socios italianos capaces para el suministro de armarios de calidad y muebles para baños, así como por el ambiente de la cocina.*

Todos los productos de excelente calidad con innumerables acabados, disponibles en muchos estilos para completar la oferta coordinada de propiedades privadas o proyectos más complejos.

La experiencia de nuestros técnicos y el gusto italiano moderno de la belleza se dan cita en una experiencia de diseño completo.



AVAILABLE HANDLES *MANIJAS DISPONIBLE*

Handle 1437



Handle 1498



Handle 2030



Handle 1349



Handle 2040



Handle 2050



WARRANTY NOTES

Your happiness
with your new **INTERNI cucine** cabinets
is important to us.

We stand behind all of our cabinets and offer you our Limited Lifetime Warranty that covers defects in the material and workmanship on **INTERNI cucine** products. This warranty is valid for domestic kitchen use and is subject to the terms and conditions stated below. Valid for indoor use only.

What does the warranty cover?

Products supplied by **INTERNI cucine** to be free of defects in materials and workmanship under normal home use and service.

How long does the warranty last?

This warranty lasts for as long as the initial purchaser of the products owns them at the original site of installation beginning upon date of delivery to you. In a residential application and non-transferable to the subsequent owner.

What will INTERNI cucine do?

INTERNI cucine will examine the product and decide, at its sole discretion, if it is covered under this warranty. If considered covered, **INTERNI cucine** will either replace defective product or repair any defects. In keeping with our policy of continued product improvement, **INTERNI cucine** reserves the right to change product specifications without notice. If a warranty claim is filed after a product has become obsolete, or has undergone design changes, we will honor the warranty in one of the following manners:

- To replace the affected component with a new component of the same style.
- To replace the affected component that is as similar and comparable in style as possible.

If components are replaced, we cannot guarantee that the finish of the new component will match the finish and appearance of existing cabinetry.

What does the warranty not cover?

This warranty does not cover or extend to:

- The natural aging or darkening of wood color, the inherent growth characteristics of, or variations in wood. This is the beauty of the wood and not a defect.
- Products or parts purchased from a non authorized **INTERNI cucine** dealer.
- Defects caused by improper handling, storage, installation, assembly or disassembly, intentional damage, product modifications, exposure to the elements including humidity which may result in warping or splitting, accidental misuse, abuse or negligence.
- Normal wear and tear, cuts or scratches, or damage caused by impacts or accidents
- Removal, shipping or reinstallation on any items or products

This warranty gives you specific legal rights and you may have other rights, which vary from state to state and province to province. Some states or provinces do not allow the exclusion or limitation of incidental or consequential damages, so the above limitations or exclusions may not apply to you.



1783 NW 38th Ave
Fort Lauderdale, FL 33311
Phone: +1 (954) 486-7000

**INTERNI CUCINE
IS PROUD MEMBER OF:**



CREDITS:

Spezie - Spices (December 2017)

Design & Concept: Neiko

Images: Neiko

Printed in Italy by: epxp rint.it

NOTICE: **NOTICIA:**

INTERNI cucine reserves the right to modify the technical characteristics of the elements contained in this catalogue without notice and shall not be liable for any inexactness contained herein.

INTERNI cucine se reserva el derecho de modificar las características técnicas de los elementos contenidos en este catálogo sin previo aviso y no será responsable por cualesquiera inexactitudes contenidas en el presente.



Spices are the symbol
of a **rooted tradition**,
always present in essence,
while **refined in**
processing and use.

Spices are the symbol of simple cuisine,
enriched by the clever use of
balanced combinations and attention to detail.

***Espicias** son el símbolo de
una **tradición arraigada**,
siempre presentes en
esencia, pero **refinados en**
el procesamiento y uso.*

*Espicias son el símbolo de una cocina sencilla,
enriquecida por el uso inteligente de
combinaciones balanceadas y atención al detalle.*

INTERNI

cucine

1783 NW 38th Ave
Fort Lauderdale, FL 33311
Phone: +1 (954) 486-7000